

FEATURES

| $R_{DS(ON)} = 125\text{m}\Omega$ (Typ.) @ $V_{GS} = 4.5\text{V}$

| $R_{DS(ON)} = 190\text{m}\Omega$ (Typ.) @ $V_{GS} = 2.5\text{V}$

| High density cell design for low RDS(on)

| Material: Halogen free

| Reliable and rugged

| Avalanche Rated

| Low leakage current



DFN1006-3L



Marking

APPLICATION

| PWM applications

| Load switch

| Power management in portable/desktop PCs

| DC/DC conversion

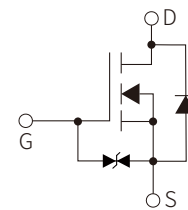

Schematic Symbol

APPROVALS

RoHS Compliance with 2011/65/EU

HF Compliance with IEC61249-2-21:2003

ABSOLUTE MAXIMUM RATINGS($T_a = 25^\circ\text{C}$)

Parameter	Symbol	Value	Unit	
Drain-Source Voltage	BV_{DSS}	20	V	
Continuous Drain Current	I_D	$T_A = 25^\circ\text{C}$	0.9	A
		$T_A = 100^\circ\text{C}$	0.6	A
Pulsed Drain Current	I_{DM}	3.6	A	
Gate-Source Voltage	V_{GS}	± 10	V	
Maximum Power Dissipation	P_D	0.23	W	
Junction-to-Ambient Thermal Resistance $t \leq 10\text{s}$	$R_{\theta JA}$	543	$^\circ\text{C}/\text{W}$	
Operating Junction Temperature	T_J	150	$^\circ\text{C}$	
Storage Temperature Range	T_{STG}	-55 to 150	$^\circ\text{C}$	

ELECTRICAL CHARACTERISTICS (T_A=25°C unless otherwise noted)

Parameter	Symbol	Test Conditions	Min	Typ	Max	Unit
Off Characteristics						
Drain-source Breakdown Voltage	V _{(BR)DSS}	V _{GS} =0V, I _D =250μA	20			V
Zero gate voltage drain current	I _{DSS}	V _{DS} =20V, V _{GS} =0V			1	μA
Gate-body leakage current	I _{GSS}	V _{GS} =±10V, V _{DS} =0V			±10	μA
On Characteristics						
Gate threshold voltage	V _{GS(th)}	V _{DS} =V _{GS} , I _D =250μA	0.4	0.65	1.0	V
Drain-source on-resistance	R _{DS(on)}	V _{GS} =4.5V, I _D =0.5A		125	165	mΩ
		V _{GS} =2.5V, I _D =0.3A		190	300	mΩ
Charges, Capacitances And Gate Resistance						
Input capacitance	C _{iss}	V _{DS} =10V, V _{GS} =0V, f=1MHz		60		pF
Output capacitance	C _{oss}			22		pF
Reverse transfer capacitance	C _{rss}			12		pF
Total Gate Charge	Q _{g(TOT)}	V _{GS} =4.5V, V _{DS} =10V I _D =0.9A		1		nC
Gate-to-Source Charge	Q _{gs}			0.28		nC
Gate-to-Drain Charge	Q _{gd}			0.22		nC
Switching Characteristics						
Turn-on Delay Time	t _{d(on)}	V _{DS} =10V, I _D =0.5A V _{GS} =4.5V, R _G =10Ω		2		nS
Turn-on Rise Time	t _r			20		nS
Turn-Off Delay Time	t _{d(off)}			10		nS
Turn-Off Fall Time	t _f			23		nS
Body Diode Characteristics						
Forward Voltage	V _{SD}	V _{GS} =0V, I _S =0.9A			1.5	V

PARAMETER CHARACTERISTIC CURVE

Fig 1: Output Characteristics

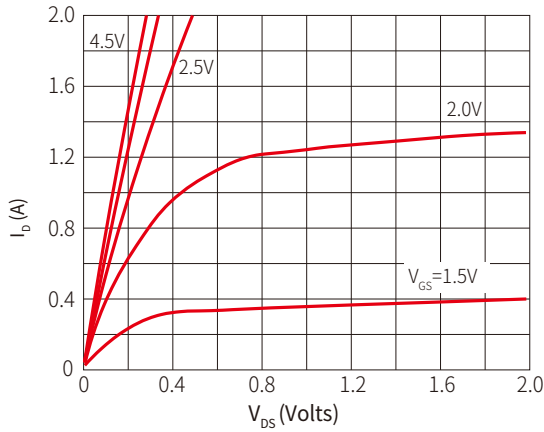

Figure 2: Typical Transfer Characteristics

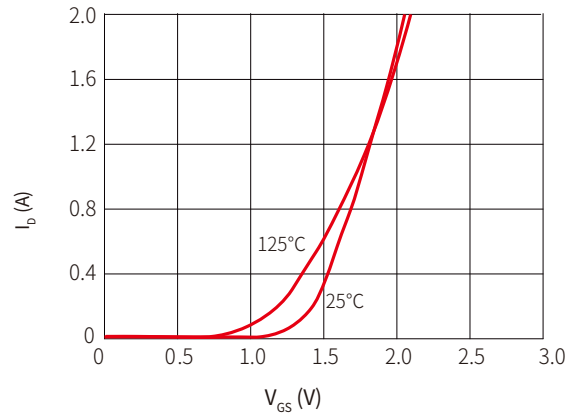

Figure 3: On-Resistance vs. Drain Current

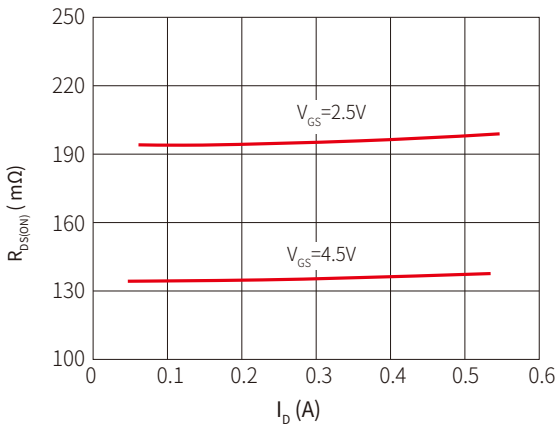

Figure 4: Body Diode Characteristics

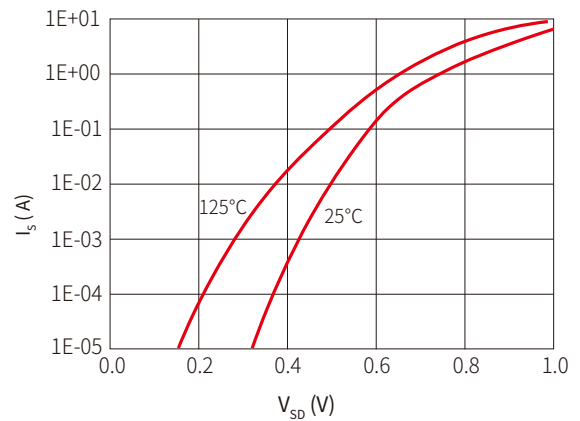

Figure 5: Gate Charge Characteristics

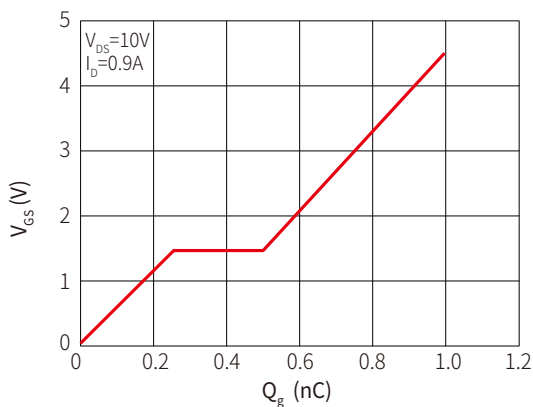

Figure 6: Capacitance Characteristics

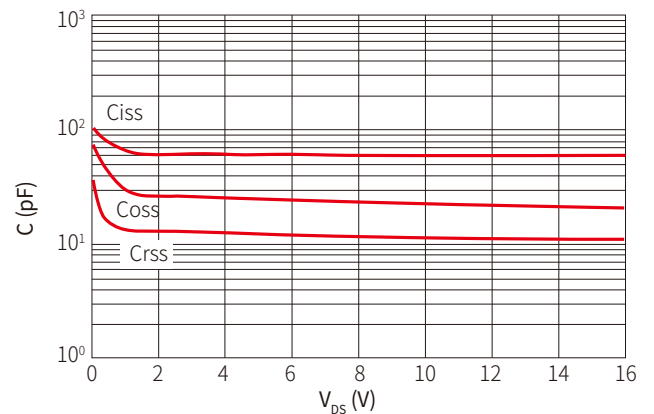

Figure 7: Normalized Breakdown Voltage vs. Junction Temperature

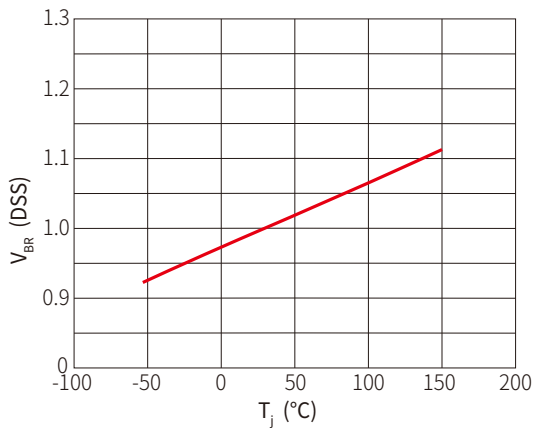

Figure 8: Normalized on Resistance vs. Junction Temperature

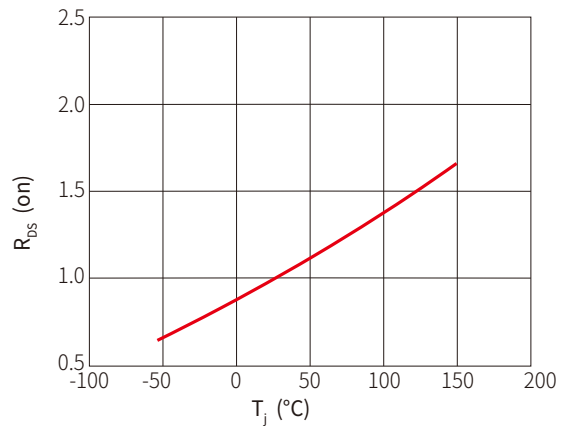

Figure 9: Maximum Safe Operating Area

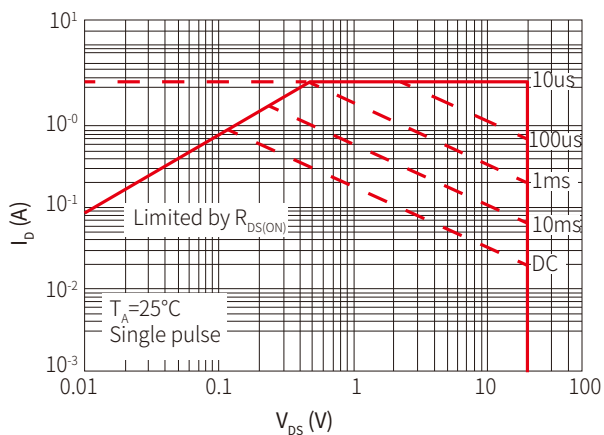

Figure 10: Maximum Continuous Drain Current vs. Ambient Temperature

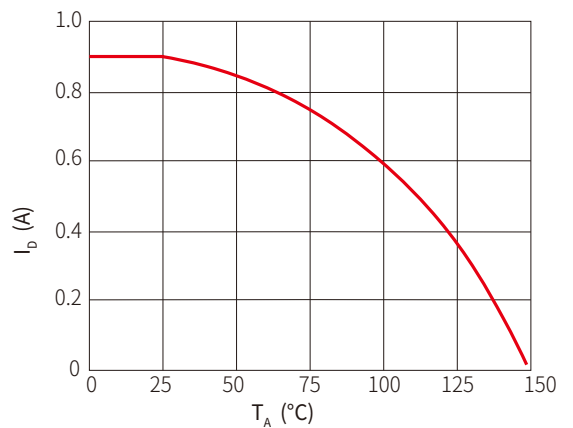
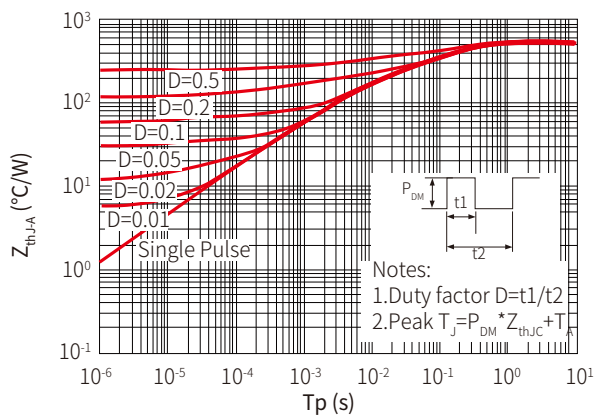
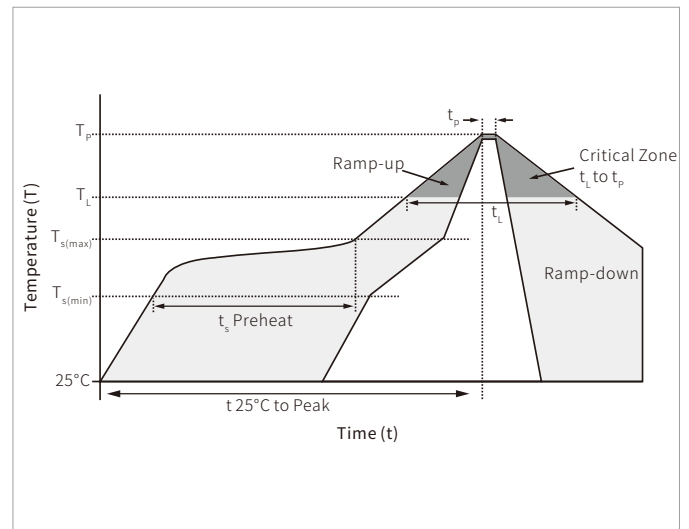

Figure 11: Maximum Effective Transient Thermal Impedance, Junction-to-Ambient



SOLDERING PARAMETERS

Reflow Condition		Lead-free assembly
Pre Heat	Temperature Max ($T_{s(min)}$)	150°C
	Temperature Max ($T_{s(max)}$)	200°C
	Time (min to max) (t_s)	60 – 180 secs
Average ramp up rate (Liquidus Temp (T_L) to peak		3°C/second max
$T_{s(max)}$ to T_L - Ramp-up Rate		3°C/second max
Reflow	Temperature (T_L) (Liquidus)	217°C
	Time (min to max) (t_L)	60 – 150 seconds
Peak Temperature (T_p)		260°C
Time within 5°C of actual peak Temperature (t_p)		20 – 40 seconds
Ramp-down Rate		6°C/second max
Time 25°C to peak Temperature (T_p)		8 minutes max.
Do not exceed		260°C



DFN1006-3L PACKAGE INFORMATION

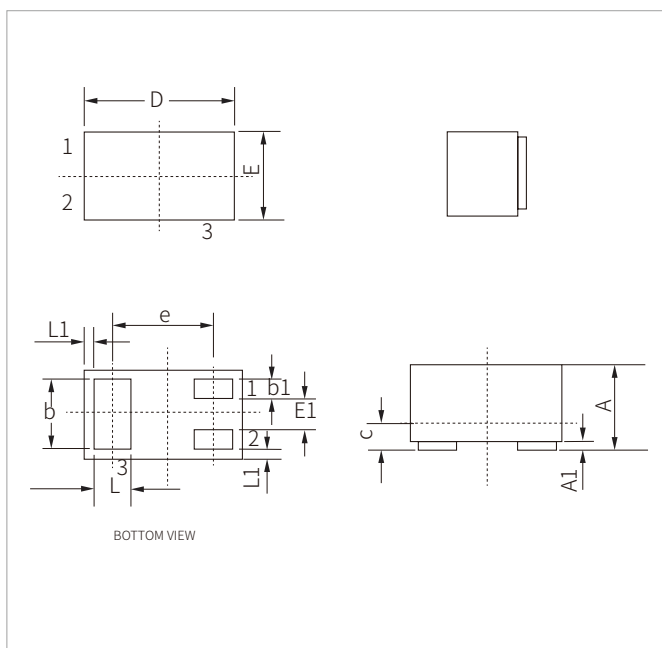

Ref.	Millimeters		Inches	
	Min.	Max.	Min.	Max.
A	0.35	0.60	0.014	0.024
A1	0	0.05	0	0.002
b	0.45	0.55	0.018	0.022
b1	0.10	0.20	0.004	0.008
c	0.12	0.18	0.005	0.007
D	0.95	1.05	0.037	0.041
e	0.65BSC		0.026BSC	
E	0.55	0.70	0.022	0.027
E1	0.20	0.30	0.008	0.014
L	0.20	0.30	0.008	0.012
L1	0.05REF		0.002REF	

RECOMMENDED PAD LAYOUT DIMENSIONS

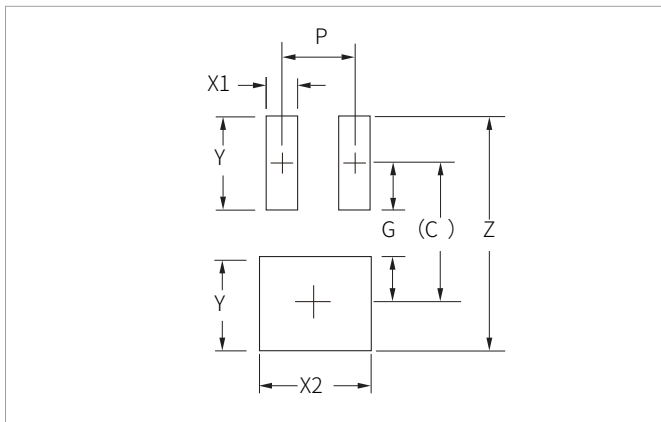

Ref.	Millimeters	Inches
C	(0.85)	(0.033)
P	0.40	0.016
G	0.30	0.012
X1	0.20	0.008
X2	0.60	0.024
Y	0.55	0.022
Z	1.40	0.055

ORDERING INFORMATION

Part Number	Component Package	QTY/Reel	Reel Size
SNM3134K	DFN1006-3L	10000PCS	7"

Headquarters

No.3387 Shendu Road
Pujiang I&E Park
Minhang Shanghai China
201000

Hotline

400-021-5756

Web

<https://www.semiware.com>

Sales Center

Tel: 86-21-3463-7458
Email: sales18@semiware.com

Customer Service

Tel: 86-21-5484-1001
Email: sales17@semiware.com

Technical Support

Tel: 86-21-3463-7654
Email: fae01@semiware.com

Complaint & Suggestions

Tel: 86-21-3463-7172
Ext: 8868
Email: cs03@semiware.com

By QR Code

Website



Wechat

To find your local partner within Semiware' s global website: www.semiware.com

© 2022 Semiware Semiconductor Inc.

The content of this document has been carefully checked and understood. However, neither Semiware nor its subsidiaries assume any liability whatsoever for any errors or inaccuracies of this document and the consequences thereof. Published specifications are subject to change without notice. Product suitability for any area of application must ultimately be determined by the customer. In all cases, products must never be operated outside their published specifications. Semiware does not guarantee the availability of all published products. This disclaimer shall be governed by substantive Chinese law and resulting disputes shall be settled by the courts at the place of business of Semiware. Latest publications and a complete disclaimer can be downloaded from the Semiware website. All trademarks recognized.