

FEATURES

- | Low profile package
- | Ideal for automated placement
- | 6600 Watt peak pulse power capability with a 10/1000µs waveform
- | For surface mounted applications to optimize board space
- | Excellent clamping capability
- | Very fast response time
- | Low incremental surge resistance

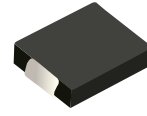

DO-214AB(SMC)

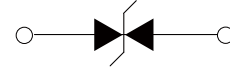

Schematic Symbol

APPLICATIONS

- | Power supply protection
- | Automotive application
- | Industrial application
- | Power management

APPROVALS

RoHS	Compliance with 2011/65/EU
HF	Compliance with IEC61249-2-21:2003

MAXIMUM RATINGS (T_A=25°C)

Parameter	Symbol	Value	Unit
Peak Pulse Power Dissipation on 10/1000µs waveform (Note1, Note2).	P _{PPM}	6600	Watts
Steady State Power Dissipation at T _L =50°C, Lead lengths.375" (9.5mm) (Note2)	P _D	6.5	Watts

- Notes :** 1.Non-repetitive current pulse,T_A=25°C.
 2.Mounted on 5.0mm*5.0mm (0.03mm thick) Copper Pads to each terminal.

THERMAL CONSIDERATIONS

Parameter	Symbol	Value	Unit
Operating Junction Temperature	T _J	-55 to +150	°C
Storage Temperature Range	T _{STG}	-55 to +150	°C
Junction to Ambient on printed circuit	R _{θJA}	75	°C/W

ELECTRICAL CHARACTERISTICS (T_A=25°C)

Part Number	Device Marking Code	Reverse Stand-off Voltage	Breakdown Voltage Min.@I _T	Breakdown Voltage Max.@I _T	Test Current	Maximum Clamping Voltage @I _{PP}	Peak Pulse Current	Reverse Leakage @V _{RWM}
		V _{RWM} (V)	V _{BR} (V)	V _{BR} (V)	I _T (mA)	V _C (V)	I _{PP} (A)	I _R (uA)
SVC660B33	6BFM	33.0	40.0	46.0	5.0	58.1	113.6	5.0

CHARACTERISTIC CURVES

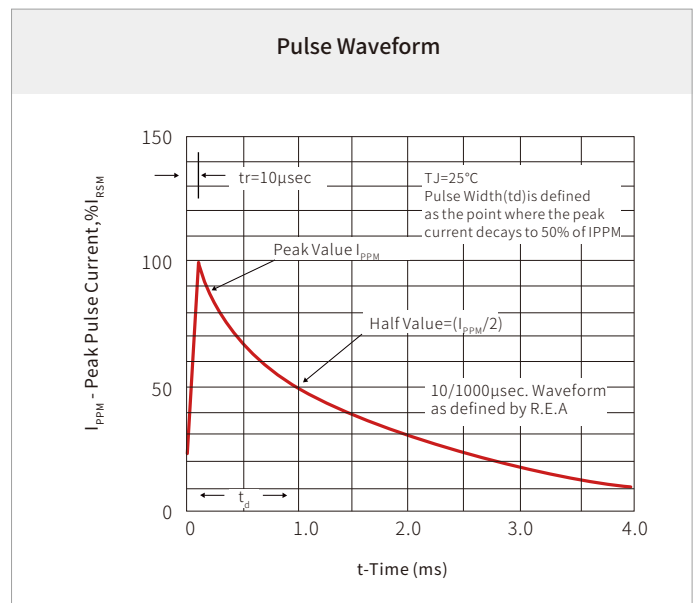
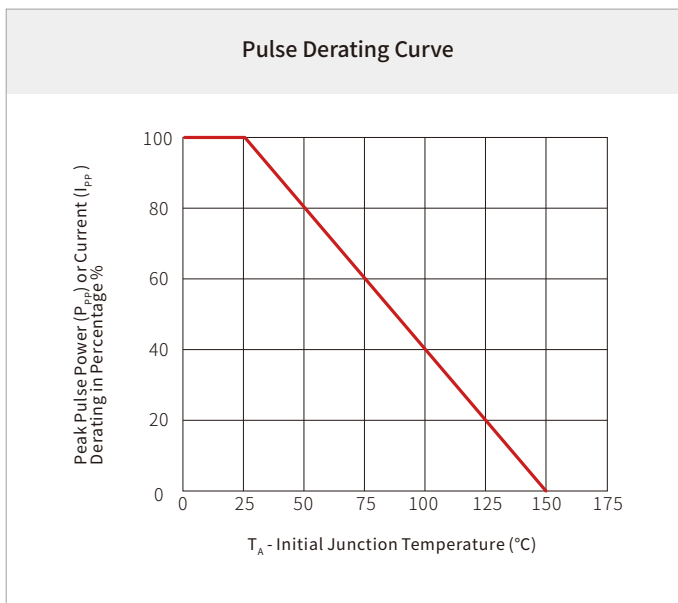
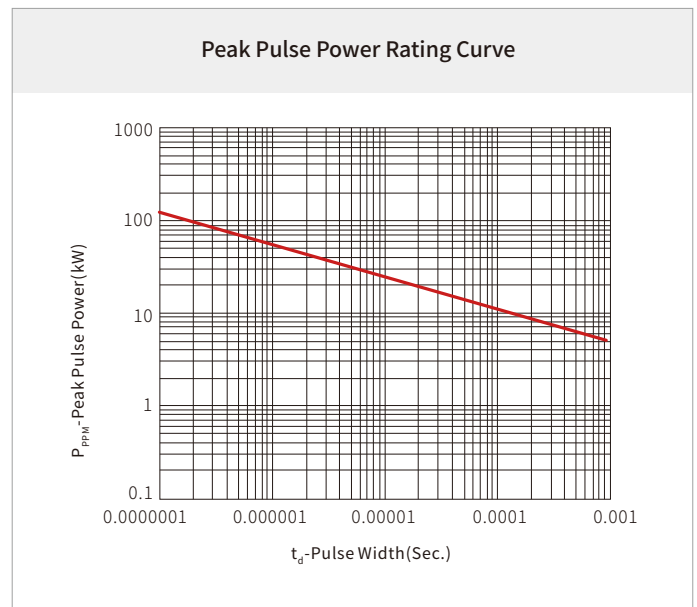
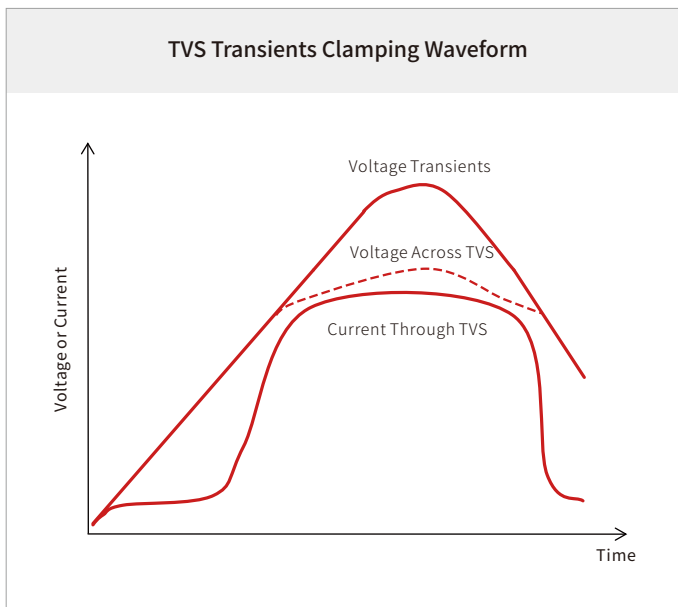

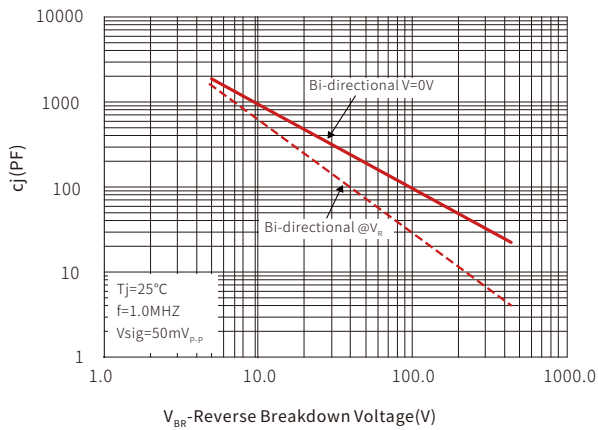
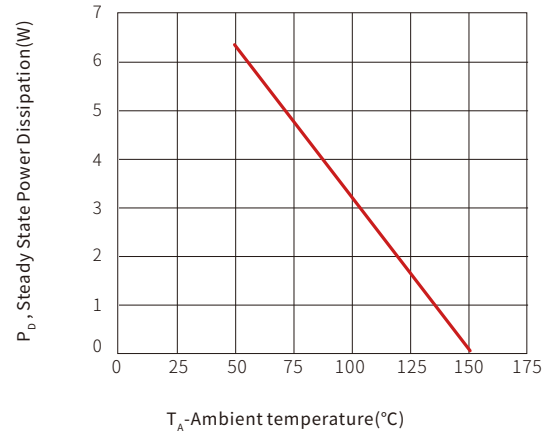
Typical Junction Capacitance

Steady State Power Dissipation Derating Curve

SOLDERING PARAMETERS

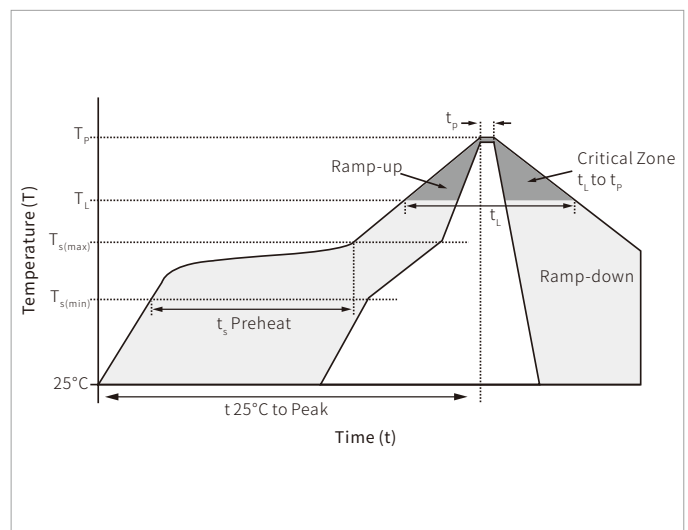
Reflow Condition		Lead-free assembly
Pre Heat	Temperature Max ($T_{s(min)}$)	150°C
	Temperature Max ($T_{s(max)}$)	200°C
	Time (min to max) (t_s)	60 – 180 secs
Average ramp up rate (Liquidus Temp (T_L) to peak)		3°C/second max
$T_{s(max)}$ to T_L - Ramp-up Rate		3°C/second max
Reflow	Temperature (T_L) (Liquidus)	217°C
	Time (min to max) (t_r)	60 – 150 seconds
Peak Temperature (T_p)		260°C
Time within 5°C of actual peak Temperature (t_p)		20 – 40 seconds
Ramp-down Rate		6°C/second max
Time 25°C to peak Temperature (T_p)		8 minutes max.
Do not exceed		260°C

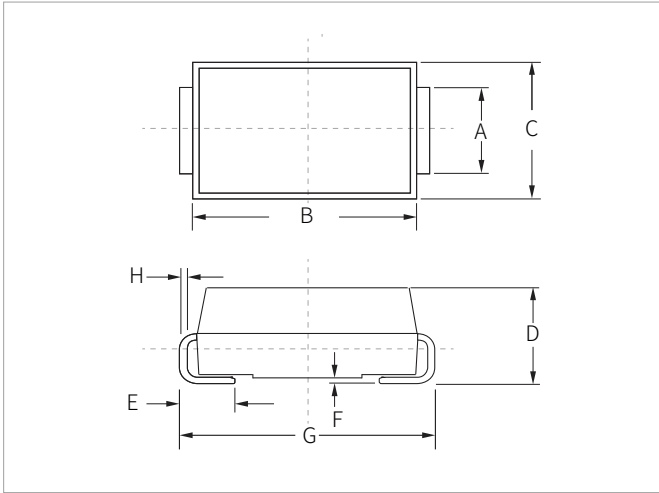

DO-214AB(SMC) PACKAGE INFORMATION



Ref.	Millimeters		Inches	
	Min.	Max.	Min.	Max.
A	2.80	3.20	0.110	0.126
B	6.60	7.20	0.260	0.283
C	5.70	6.10	0.224	0.240
D	2.15	2.75	0.085	0.108
E	1.00	1.60	0.039	0.063
F	0.02	0.20	0.000	0.008
G	7.60	8.00	0.299	0.315
H	0.15	0.30	0.006	0.012

RECOMMENDED PAD LAYOUT DIMENSIONS

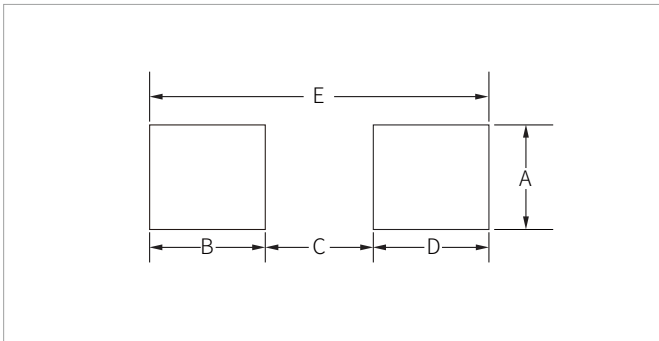

Ref.	Millimeters		Inches	
	Min.	Max.	Min.	Max.
A	3.30	-	0.129	-
B	2.40	-	0.094	-
C	-	4.20	-	0.165
D	2.40	-	0.094	-
E	8.20REF		0.323REF	

ORDERING INFORMATION

Part Number	Component Package	QTY/Reel	Reel Size
SVC660B33	DO-214AB(SMC)	3000PCS	13"

Headquarters

No.3387 Shendu Road
Pujiang I&E Park
Minhang Shanghai China
201000

Hotline

400-021-5756

Web

<https://www.semiware.com>

Sales Center

Tel: 86-21-3463-7458
Email: sales18@semiware.com

Customer Service

Tel: 86-21-5484-1001
Email: sales17@semiware.com

Technical Support

Tel: 86-21-3463-7654
Email: fae01@semiware.com

Complaint & Suggestions

Tel: 86-21-3463-7172
Ext: 8868
Email: cs03@semiware.com

By QR Code

Website



Wechat

To find your local partner within Semiware' s global website: www.semiware.com

© 2022 Semiware Semiconductor Inc.

The content of this document has been carefully checked and understood. However, neither Semiware nor its subsidiaries assume any liability whatsoever for any errors or inaccuracies of this document and the consequences thereof. Published specifications are subject to change without notice. Product suitability for any area of application must ultimately be determined by the customer. In all cases, products must never be operated outside their published specifications. Semiware does not guarantee the availability of all published products. This disclaimer shall be governed by substantive Chinese law and resulting disputes shall be settled by the courts at the place of business of Semiware. Latest publications and a complete disclaimer can be downloaded from the Semiware website. All trademarks recognized.